

Type MTS Miniature Test Switches

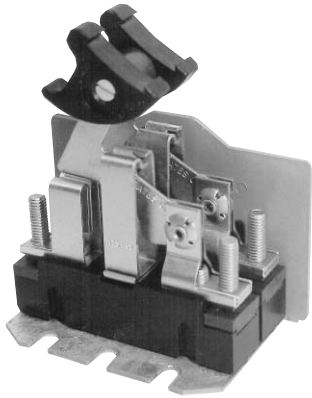

- **Compact and versatile**
- **Front- and back-connected styles**
- **Safe, durable, rugged and reliable**
- **Recognized by CUL & UL**
- **Class 1E qualified per IEEE Standard 323-1974**

DESCRIPTION

In many panelboard, switchgear, metering, control circuit and instrumentation applications, space is at a premium. Yet provisions must be made to facilitate troubleshooting, testing, calibration and checkout of relays, meters, transducers, instruments and control systems. STATES Type MTS Miniature Test Switches are the compact, versatile solution for disconnecting and testing these devices and circuits.

They are the result of over 60 years of experience in the design and manufacture of test switches, and make use of the latest improvements in material composition and construction techniques.

Many features are incorporated for increased safety, durability, ruggedness and reliability. All the features you need, including potential elements, current elements and make-before-break short-circuiting elements for current transformer circuits and test jacks, are available in test switches ranging from 1 to 52 poles on one base, and in a miniature size.

Each switch blade can be operated independently or, where required, adjacent handles can be ganged for simultaneous operation.

All Type MTS Test Switches are available in both front- and back-connected styles. Protective covers are automatically included with all back-connected styles and may be ordered as an optional item with front-connected switches.

CLASS 1E QUALIFIED PER IEEE STANDARD 323-1974

Type MTS Test Switches have successfully completed a generic test program that meets the requirements of most nuclear power plants for Class 1E applications outside containment.

Extensive accelerated-life testing was conducted by an outside, independent firm using thermal aging, mechanical aging, environmental extremes, radiation exposure and seismic simulation to conduct tests.

The service conditions and parameters of the test program included:

- 41-year life at 131° F (55° C), 600 operations, 95% humidity, 2.2 x 10⁸ rads of radiation and 10g maximum acceleration seismic level.
- Recognized by UL and CUL
- Underwriters Laboratories Inc. recognizes STATES Type MTS Miniature Test Switches under its component program, File No. E75355, with a rating of 600 volts, 30 amperes.

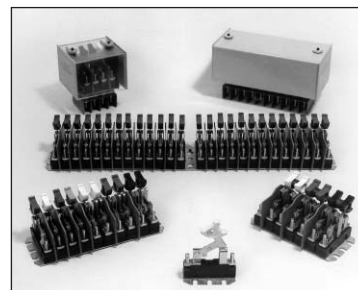

Space-saving miniaturization means full test capability; yet, a Type MTS 10-pole switch requires just 7 inches of mounting space. Unit-pole construction permits virtually any pole arrangement from 1 to 52 poles mounted on a single base.

STATES

FEATURES AND BENEFITS

- **Self-extinguishing materials:** All non-metallic components are made of self-extinguishing, flame-retardant materials with Underwriters Laboratories' best rating for self-extinguishing materials (V-O).
- **Nonferrous material:** All current-carrying metallic components, including hardware, are made of highest quality nonferrous materials such as copper, bronze, brass or phosphor bronze. This ensures excellent conductivity and minimizes galvanic action between dissimilar metals.
- **Nickel plating:** All current-carrying metallic components, including hardware, have a corrosion-resistant nickel finish that ensures good electrical contact and smooth operation of moving parts even after years of inactivity.
- **Safety-grip handle:** A molded handle covers the terminal and includes a lower lip that projects over the metal parts of the switch, thus protecting the operator from contact with live components.
- **One-piece jaw and hinge:** One-piece construction of hinge and jaw eliminates unnecessary, multiple connection points.
- **Special blade shape:** All blades are shaped so that the edge of the blade enters at a right angle to the jaw; thus, the blade enters and exits the full width of the jaw simultaneously.
- **Switch jaws:** All STATES Test Switches have uniform contact pressure over the full width of the blade. The "ping" heard when opening the blade is due to the special, spring-grade phosphor bronze used in the jaw. This design ensures an excellent low-resistance contact that will not overheat.
- **High barriers:** Maximum circuit isolation is obtained by extra-high barriers that provide uncompromised protection. Barriers are permanently mounted and cannot fall out or be knocked out, as in some "snap-in" designs.
- **Short-circuit jaw:** A rugged, make-before-break element is used to short the secondary of a current transformer.
- **Fixed terminal studs:** The screw terminals on which wiring connections are made are a part of a rigid, immovable assembly and cannot be turned or backed out.
- **Test jack:** The test jack eliminates the possibility of opening current transformer secondaries and permits safe, easy measurements to be made in current circuits without disturbing permanent wiring. A dual-circuit test plug, such as the STATES Cat. No. 15000, inserted into the test jack puts the measuring instrument in series with the current circuit. The test jack does not carry current except when making a test because it is shunted by a standard switch blade that is opened only when the test jack is used.
- **Color-coded handles:** Unless otherwise specified, potential elements have red handles and current elements have black; however, the following other colors are available at additional cost: blue, orange, white, yellow, green.
- **Identification card holder:** Each safety grip handle is slotted for insertion of an identification card for marking or coding. Cards are available under Cat. No. MTS28.

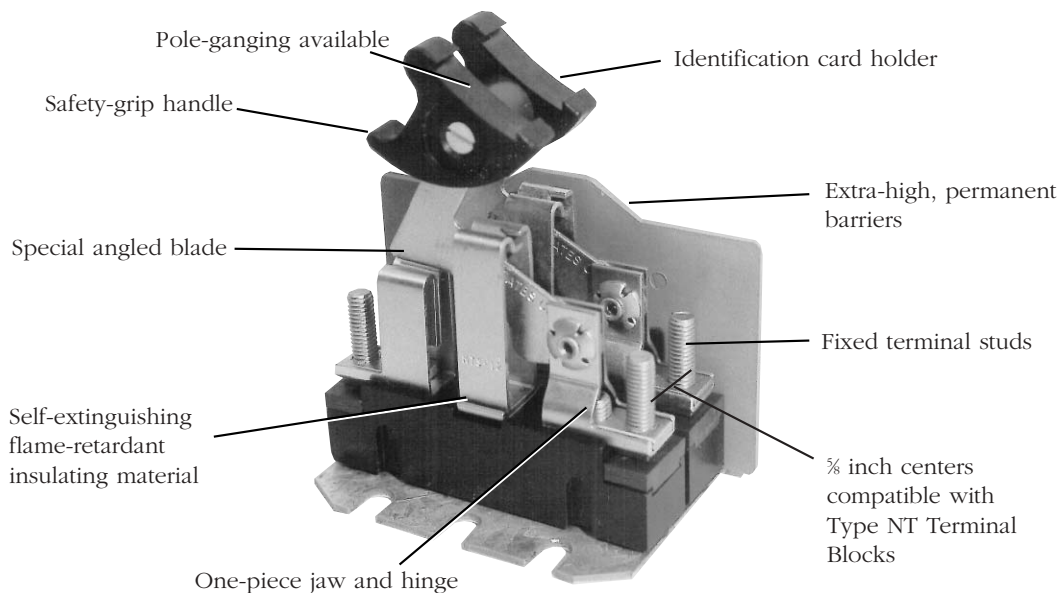

STATES Type MTS Test Switch

STATES

All configurations are available in either a front- or back-connected style.

FRONT-CONNECTED SWITCHES

The front-connected test switch usually is used where wiring entering and leaving the test switch is located on the same side of the panel that the test switch is mounted.

To order front-connected switches, refer to [Ordering Information](#).

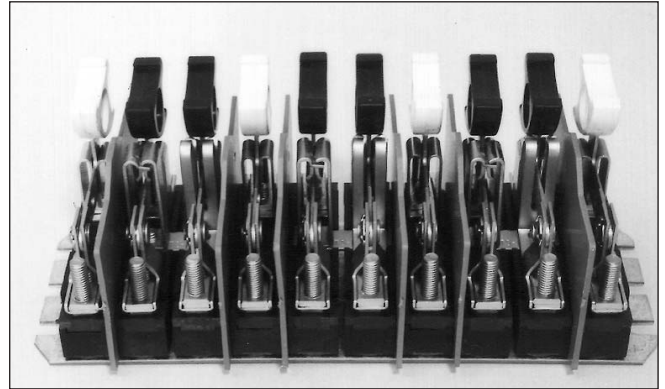

Front-connected type

BACK-CONNECTED SWITCHES

All switches can be provided in a back-connected version so that the switch is mounted on one side of a panel and the wiring connections are made on the opposite side.

Back-connected switches have factory-installed insulated barriers that project from the rear of the switch. They include either clear or opaque covers.

To order back-connected switches, refer to [Ordering Information](#).

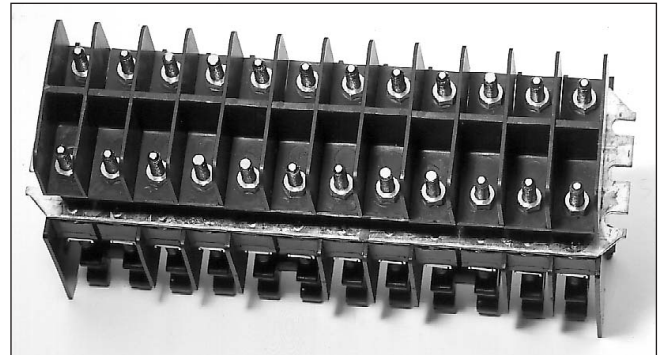

Back-connected types

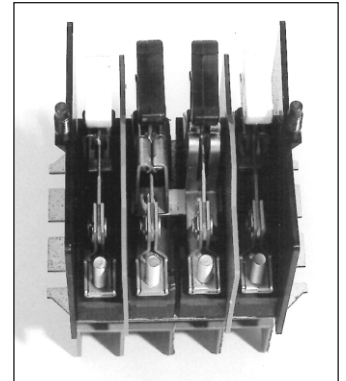

STATES

COVERS

STATES Type MTS Test Switches feature rugged, virtually unbreakable covers available in clear or opaque styles. These covers are manufactured from tough, self-extinguishing, flame-retardant polycarbonate. The covers are constructed so

that all switch blades must be closed when the cover is properly sealed. Switches provided with covers include two insulated studs that have holes for wire seals. To add a cover, refer to **Ordering Information**.

COVERS FOR FRONT-CONNECTED SWITCHES

Covers for front-connected switches are open or slotted at the bottom of each side to permit wiring to enter and exit between the cover and the panel.



Slotted, front-connected clear cover



Front-connected opaque (C1) cover

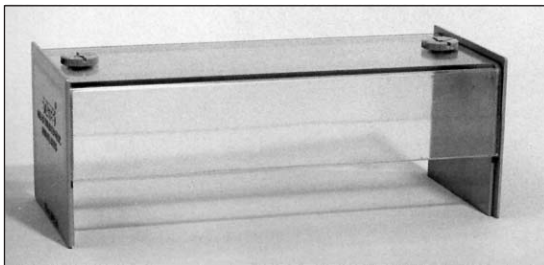

Front-connected clear (C3) cover

COVERS FOR BACK-CONNECTED SWITCHES

A cover is automatically included with a back-connected test switch. However, you must select either a clear or opaque style.

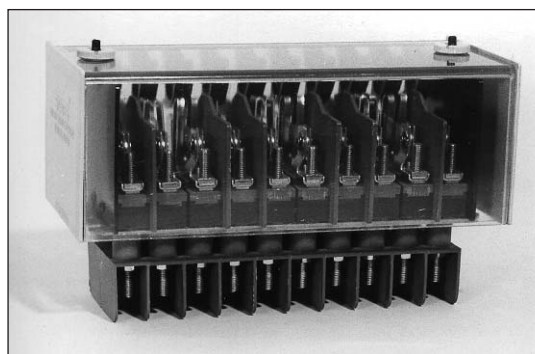

Nonslotted, back-connected clear cover – The nonslotted covers for back-connected switches fit flush with the panel because all wiring exits at the rear of the test switch.

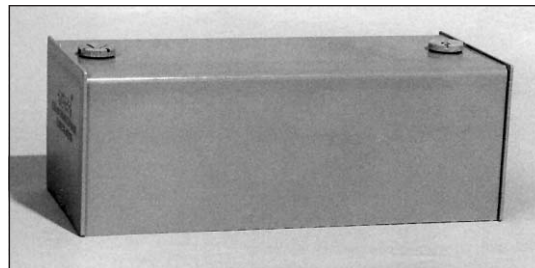

Back-connected opaque (C2) cover

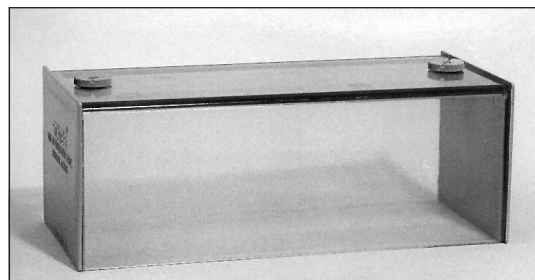

Back-connected clear (C4) cover

STATES

TYPICAL INSTALLATIONS FOR STATES TYPE MTS TEST SWITCHES

1 ϕ Watt Transducer

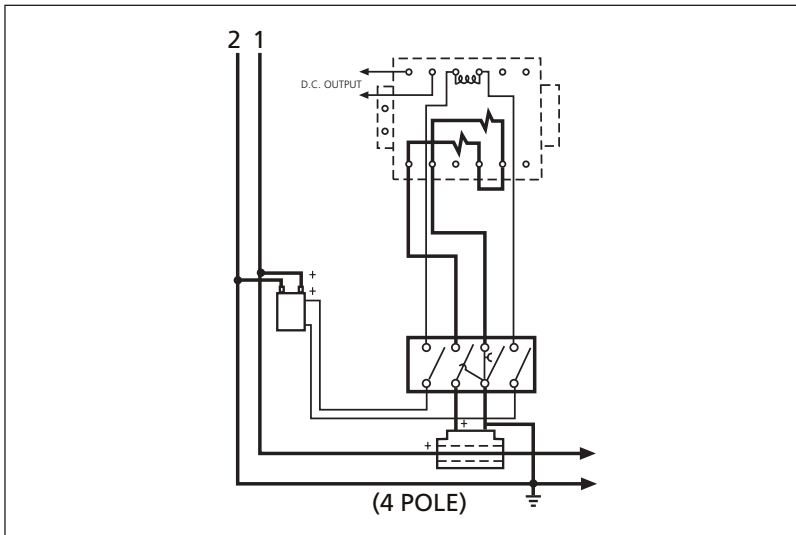

4-Pole Test Switch - Cat. No. 204-N

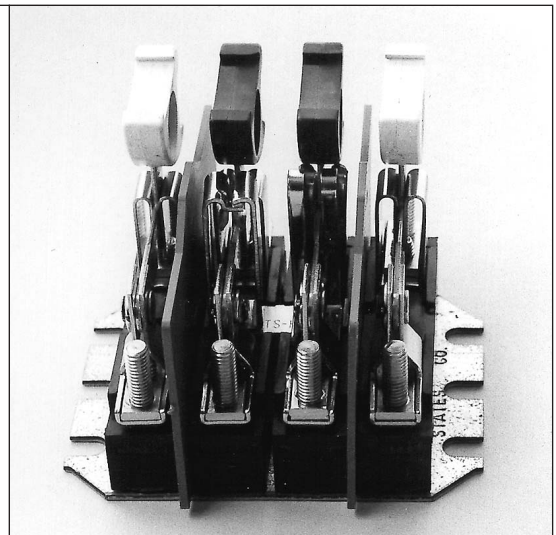

3 ϕ Watthour Meter

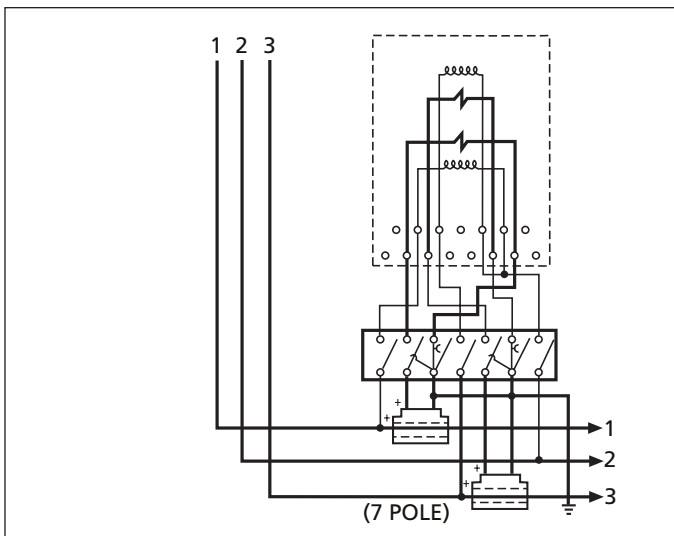

7-Pole Test Switch - Cat. No. 207-K



Overcurrent Relays

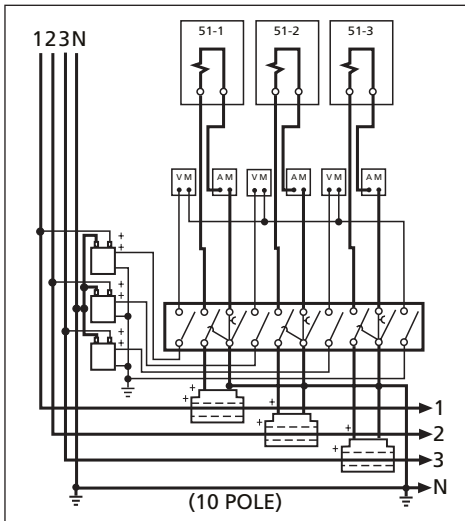

10-Pole Test Switch - Cat. No. 210-E

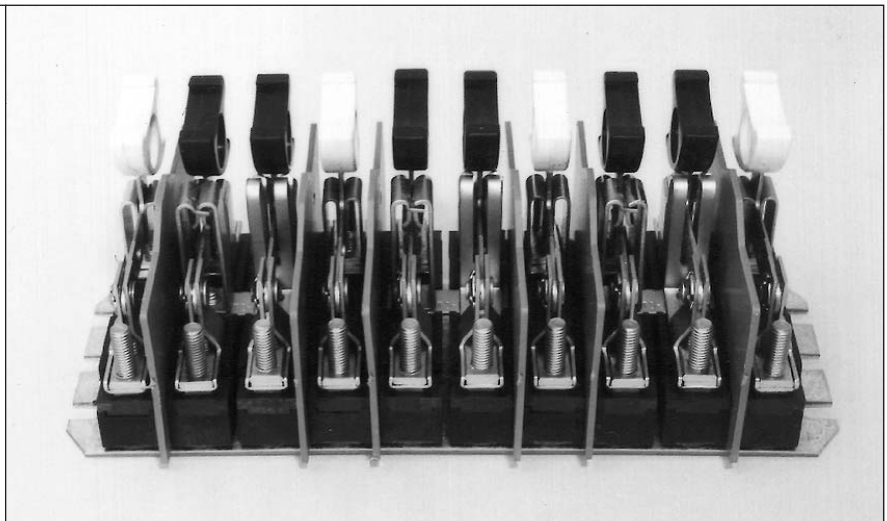

ORDERING INFORMATION

The catalog numbers under the arrangements on the following pages are for front-connected switches without covers. These same numbers are also used as the basis for ordering back-connected.

The catalog numbers are three digits followed by a letter or number combination.

Example: 203-A

1/1/1



203-A

The slashes “/” in the arrangements represent barriers that are installed standard between any adjoining elements of opposite polarity.

To order front-connected switches

Specify the catalog numbers shown under the arrangements on the following pages.

Example: 210-A

For covers, add the appropriate prefix:

Cover	Prefix
Front-connected, slotted, opaque	C1
Front-connected, slotted, clear	C3

Example: C3-210-A

To order back-connected switches

Specify the desired arrangement and add the suffix -B.

Example: 210-A-B

All back-connected switches are provided with either a clear or opaque cover. For covers, add the appropriate prefix:

Cover	Prefix
Back-connected, solid, opaque	C2
Back-connected, solid, clear	C4

Example: C4-210-A-B

Special Orders

Special Arrangements: In addition to the typical arrangements shown on the following pages, special arrangements are available. These can be made of any combination of potential or current elements, with a maximum of 52 poles. For more information, refer to the following example and illustrations on Page 38.

To order a customized, 10-pole, back-connected switch with a clear, back-connected cover, specify:

Switch Type: STATES Type MTS

No. of poles: 10-pole test switch

Arrangement: 10/2/11/1/16

Style: Back-connected

Cover: Clear, back-connected

Handle Colors: The standard colors for handles are red for potential and black for current. Handles are also available in other colors.

To specify non-standard colors, add to the element number the appropriate color code:

Color	Color Code	Color	Color Code
Black	k	Red	r
Blue	b	White	w
Green	g	Yellow	y
Orange	e		

To order a switch with handles in non-standard colors, you must specify the arrangement with colors indicated. For example, to order a 10-pole switch with special handle colors, specify:

Arrangement: 10/10r/10g/10w/1k/1k

Ganged handles: You may specify a yoking bar to gang adjacent handles. For example, to order a switch with the adjacent potentials ganged, you must specify:

Gang all potentials

Hinge position: The “U” in an arrangement indicates the hinge is positioned upside down from the typical arrangement.

OPTIONAL ACCESSORIES



Socket Wrench and Insert

To speed installation of the terminal nuts on STATES Test Switches, the socket wrench (Cat. No. 16028) and $\frac{3}{8}$ inch insert (Cat. No. 16027) are available.

Also available are the $\frac{5}{16}$ inch insert (Cat. No. 16025) for use in installing the terminal nuts on STATES Type Terminal Blocks and STATES Type MTS Test Switches.

The screwdriver attachment (Cat. No. 16022) makes this wrench your complete meter installation tool.

Dual Circuit Plug

By inserting the STATES Dual Circuit Plug (Cat. No. 15000) into the test jack, safe measurement can be made of current transformer secondary current.



Jumper Strips

Cat. No. TBT167 2 Pole Strap

Cat. No. TBT168 58 Pole Strap

(The TBT168 can be cut to the required length)

This nickel-plated jumper strip is made specially for the STATES Type NT & ZWM Terminal Blocks and the STATES Type MTS Test Switches.



STATES

FRONT VIEW 1-POLE

1



201-A

Color Options: **1k**
201-C
1y
201-D

9



201-B

2-POLE

1/1



202-A

Color Options: **1k/1k**
202-H
1y/1y
202-D

2



202-B

2k
202-J

10



202-C

11



202-F

Color Option: **11r**
202-L

13



202-E

Other 2-Pole
Standard Arrangement:

6-24
202-G

3-POLE

1/1/1



203-A

16



203-D

1/10



203-B

10/1



203-C

13/1



203-H

1/13



203-J

17



203-E

Other 3-Pole
Standard Arrangements:

6-6-5
203-K

6-6-24
203-L

9/9/9
203-F

9/24-5
203-G

4-POLE

1/1/1/1



204-A

2/2



204-D

Color Option: **2k/2k**
204-A2

1/1/1/1

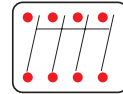

204-E

1/1/10

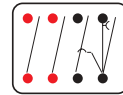

204-F

1/1/11



204-J

10/1/1

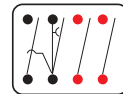

204-K

10/2

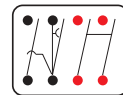

204-G

1/10/1



204-N

11/10

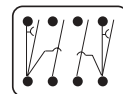

204-Q

4-POLE (CONT.)

1/1/13



204-B

1/13/1



204-L

13/1/1



204-M

13/13

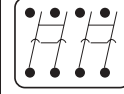

204-H

20-24

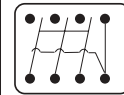

204-C

Other 4-Pole
Standard Arrangements:

1/10/24
204-A3

1/16
204-A5

9/9/9/9
204-R

9/24-14
204-S

11/11
204-W

11b/11e
204-Z

20-9
204-A4

20r-24
204-U

24-19r
204-T

Color Key: **k:** Black **b:** Blue **g:** Green **e:** Orange **r:** Red **w:** White **y:** Yellow

STATES

FRONT VIEW

5-POLE

1/1/1/1/1

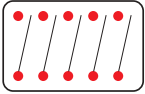

205-A

1/1/16

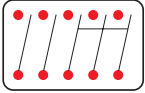

205-H

1/1/1/10

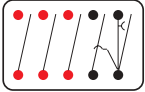

205-B

1/1/10/1



205-C

1/10/1/1



205-D

10/1/10

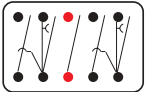

205-F

11/1/10



205-G

9/9/9/9/24

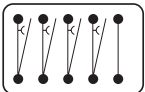

205-J

1/1/1/13

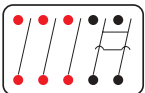

205-E

6-POLE

1/1/1/1/1/1

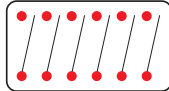

206-A

2/2/2

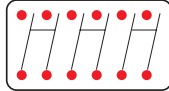

206-D

16/16

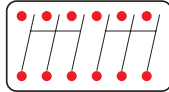

206-E

1/1/1/10/1

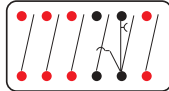

206-F

1/10/10/1

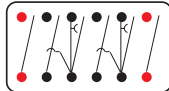

206-G

1/1/10/10

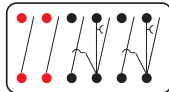

206-J

11/11/11

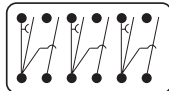

206-K

10/10/10

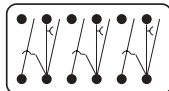

206-C

1/13/13/1

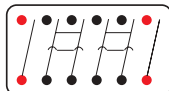

206-H

6-Pole (CONT.)

1/1/13/13

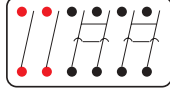

206-S

13/13/13

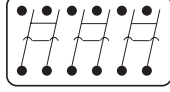

206-B

Other 6-Pole
Standard Arrangements:

1/1/1/1/11

206-P

2/2/13

206-L

7-POLE

1/1/1/1/1/1/1

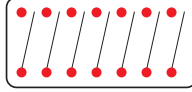

207-A

1/10/1/1/1/1

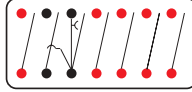

207-G

1/1/10/1/1/1

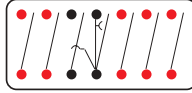

207-F

1/1/1/1/10/1



207-H

16/10/10

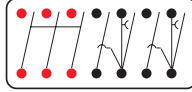

207-J

7-Pole (CONT.)

1/10/1/10/1

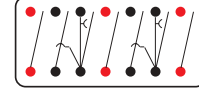

207-K

1/10/1/11/1

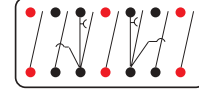

207-B

1/1/1/10/10

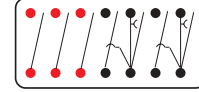

207-C

Color Option:

1k/1k/1k/10/10
207-P

1/1/1/10/11



207-E

1/13/1/13/1

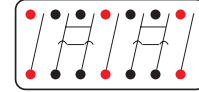

207-D

13/13/13/9

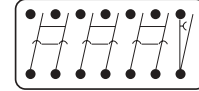

207-L

Other 7-Pole
Standard Arrangements:

#1/1/1/1/1/1/1#

207-M

1/1/1/1/11/11

207-Q

1/6-1-6-9-9/1

207-N

6-6-6-6-6-6-24

207-S

9/9/9/24-19

207-R

STATES

FRONT VIEW

8-POLE

1/1/1/1/1/1/1/1

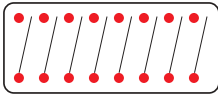

208-D

1/1/1/10/1/1/1

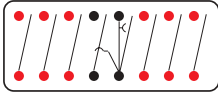

208-E

1/10/1/1/11/1

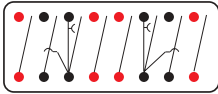

208-A

10/10/1/1/1/1

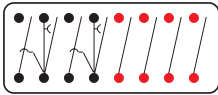

208-B

1/1/1/1/10/10

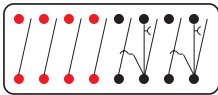

208-G

1/10/10/10/1

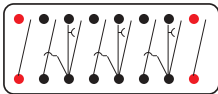

208-K

10/10/10/1/1

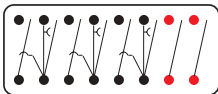

208-L

10/10/10/10

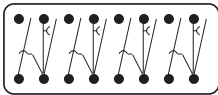

208-P

1/1/1/13/1/1/1

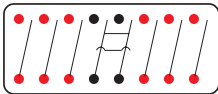

208-Q

8-Pole (CONT.)

1/1/1/1/1/1/1/3

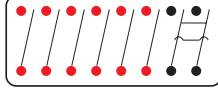

208-C

1/13/1/1/13/1

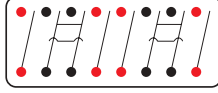

208-H

1/1/1/1/13/13



208-J

16/24/13/13

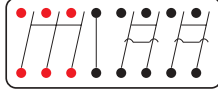

208-F

1/13/13/13/1

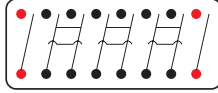

208-M

13/13/13/1/1

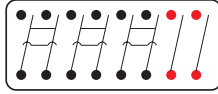

208-N

13/13/13/13

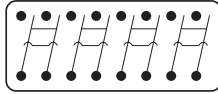

208-W

Other 8-Pole
Standard Arrangements:

#1/1/1/1/1/1/1/1#
208-T

1/6-1-6-9-1-9/1
208-R

2/2/2/2
208-S

9-POLE

1/1/1/1/1/1/1/1/1

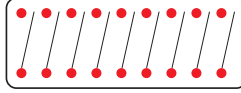

209-A

16/16/16

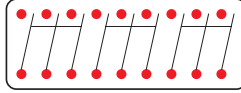

209-B

1/1/1/10/10/10

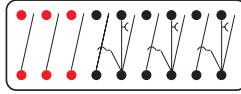

209-U

16/10/10/10



209-E

1/10/1/10/1/10

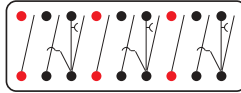

209-K

1/13/1/13/1/13

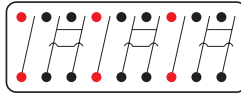

209-H

1/1/1/13/13/13

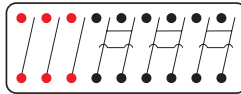

209-D

6-6-6-6-6-6-6-24

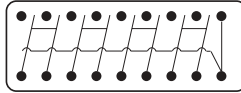

209-C

Other 9-Pole
Standard Arrangements:

1/1/24/10/10/10
209-F

9/9/9/9/9/9/9/1
209-G

11/9/11/9/11/9
209-J

10-POLE

1/1/1/1/1/1/1/1/1/1

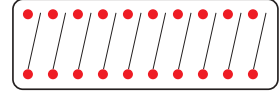

210-A

1/1/1/1/1/1/1/10/1

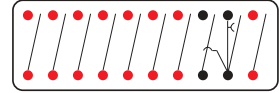

210-B

1/1/1/1/1/10/10/1

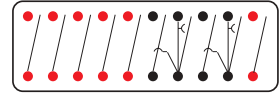

210-C

1/1/1/10/1/1/10/1

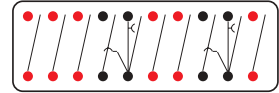

210-D

1/10/1/1/1/1/10/1

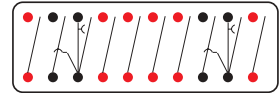

210-F

1/10/1/10/1/10/1

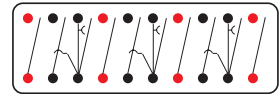

210-E

1/1/1/1/10/10/10

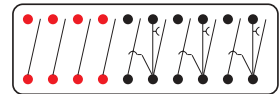

210-H

1/1/1/10/10/10/1

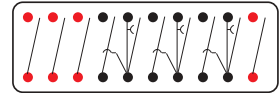

210-J

1/10/10/10/10/1

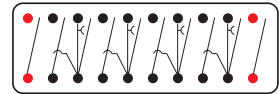

210-K

10/10/10/10/1/1

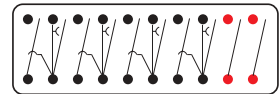

210-L

Color Key: k: Black b: Blue g: Green e: Orange r: Red w: White y: Yellow

STATES

FRONT VIEW

10-Pole (CONT.)

10/10/10/10/10

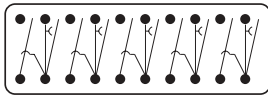

210-M

1/13/1/13/1/13/1

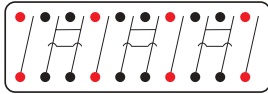

210-G

13/13/13/13/13

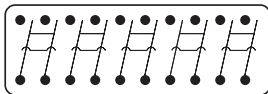

210-N

13/13/13/1/1/24

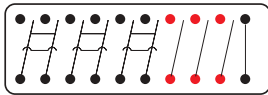

210-P

Other 10-Pole
Standard Arrangements:

1/1/1/24/10/10/10
210-T

1/1/1/24/13/13/13
210-AA

1/10/1/10/1/10/24
210-R

2/2/2/2/2
210-Y

9/9/9/9/9/9/9/9/9/9
210-Q

9/9/9/9/24-5-5-5-5-5
210-V

9/9/9/24#-19-19#
210-U

10/10/10/1/1/1/1
210-W

13/13/13/13/13
210-X

1/1/1/1/9-5-9-5-9-5
210-S

11-POLE

1/1/1/1/1/1/1/1/1/1/1
211-A

10/10/9/10/9/9/2
211-C

13/13/1/1/1/1/1/1/1
211-B

12-POLE

1/1/1/1/1/1/1/1/1/1/1/1

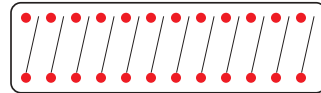

212-A

2/2/2/2/2/2

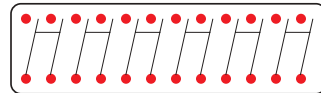

212-B

1/1/1/1/1/1/1/1/1/1/1/1

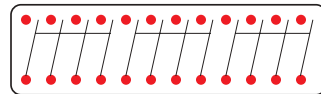

212-C

10/10/10/10/10/10

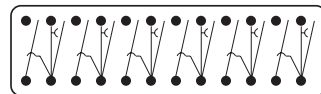

212-D

Other 12-Pole
Standard Arrangements:

1/1/10/1/10/1/10/1/1
212-F

1/10/1/10/1/10/1/10
212-E

9/9/9/9/9/9/9/9/9/16
212-H

13/13/13/13/13/13
212-G

16-POLE

16 - #1 elements

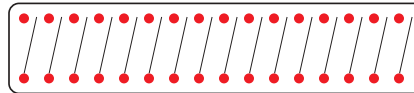

216-A

8 - #2 elements

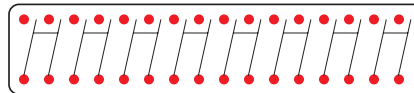

216-B

Other 16-Pole
Standard Arrangements:

1/1/1/1/13/13/1/1/1/1/1/1/1
216-D

1/1/1/24/10/10/10/10/10/10
216-C

21-POLE

21 - #1 elements

221-A

13/13/13/24/13/13/13/24/13/13/13/24
221-B

24/13w/13g/13k/24/13w/13g/13k/24/13w/13g/13k
221-C

221-C

13k/13g/13w/24/13k/13g/13w/24/13k/13g/13w/24
221-D

221-D

22-POLE

22 - #1 elements

222-A

2/2/2/2/2/2/2/2/2/2/2/2
222-B

222-B

24-POLE

24 - #1 elements

224-A

12 - #2 elements

224-B

12 - #13 elements

224-E

26-POLE

26 - #1 elements

226-A

26 - #1k elements

226-K

40-POLE

40 - #1 elements

240-A

20 - #13 elements

240-B

52-POLE

52 - #1 elements











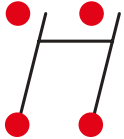
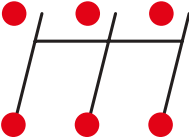

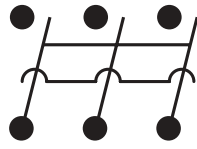
252-A

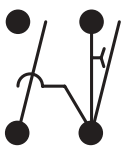
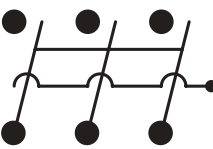
26 - #13 elements

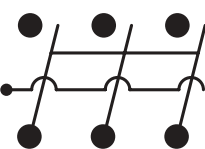
252-B

STATES

ELEMENTS FOR CUSTOMIZED SWITCHES NOT LISTED UNDER TYPICAL ARRANGEMENTS

<p>1</p>  <p>Single-Pole Potential</p>	<p>2</p>  <p>Ganged Double-Pole Potential</p>	<p>16</p>  <p>Ganged Three-Pole Potential</p>
<p>13</p>  <p>Ganged Two-Pole Short-Circuiting Current Assembly</p>	<p>17</p>  <p>Ganged Three-Pole Short-Circuiting Current Assembly</p>	<p>9</p>  <p>Current Test Jack</p>
<p>6</p>  <p>Short-Circuiting Assembly With Right-Hand Common Bar</p>	<p>10</p>  <p>Right-Hand Current Assembly Consists of Test Jack and Short-Circuiting Current Assemblies</p>	<p>20</p>  <p>Ganged Three-Pole Short-Circuiting Current Assembly, Right Extension</p>
<p>5</p>  <p>Short-Circuiting Assembly With Left-Hand Common Bar</p>	<p>11</p>  <p>Left-Hand Current Assembly Consists of Test Jack and Short-Circuiting Current Assemblies</p>	<p>19</p>  <p>Ganged Three-Pole Short-Circuiting Current Assembly, Left Extension</p>
<p>90</p>  <p>Right-Hand Short-Circuiting Assembly Ending at a Terminal</p>	<p>91</p>  <p>Left-Hand Short-Circuiting Assembly Ending at a Terminal</p>	<p>24</p>  <p>Through Bar</p>
<p>25</p>  <p>600-Volt Fuse Holder</p>	<p>25A</p>  <p>250-Volt Fuse Holder</p>	<p>26</p>  <p>Blank Space</p>

NOTES:

1. Barriers are provided between poles of opposite polarity.
2. Potential handles are red and current handles are black unless otherwise specified.
3. Specify adjacent handles to be ganged (yoked) if desired.
4. Arrange elements left to right, front view.

Color Key: k: Black b: Blue g: Green e: Orange r: Red w: White y: Yellow

STATES

Dimensions (in inches)

NUMBER OF POLES	A	B	C	D	E
1	1 3/8	1 1/8	9/16	1 13/16	43/64
2	2	1 3/4	1 3/16	2 1/2	1 19/64
3	2 5/8	2 7/32	1 13/16	3 1/8	1 59/64
4	3 1/4	3	2 7/16	3 3/4	2 35/64
5	3 7/8	3 5/8	3 1/16	4 3/8	3 11/64
6	4 1/2	4 1/4	3 11/16	5	3 51/64
7	5 1/8	4 7/8	4 5/16	5 5/8	4 27/64
8	5 3/4	5 1/2	4 15/16	6 1/4	5 3/64
9	6 3/8	6 1/8	5 9/16	6 7/8	5 43/64
10	7	6 3/4	6 3/16	7 1/2	6 19/64
11	7 5/8	7 3/8	6 13/16	8 1/8	6 59/64
12	8 1/4	8	7 7/16	8 3/4	7 35/64
13	8 7/8	8 5/8	8 1/16	9 3/8	8 11/64
14	9 1/2	9 1/4	8 11/16	10	8 51/64
15	10 1/8	9 7/8	9 5/16	10 5/8	9 27/64
16	10 3/4	10 1/2	9 15/16	11 1/4	10 3/64
17	11 3/8	11 1/8	10 9/16	11 7/8	10 43/64
18	12	11 3/4	11 3/16	12 1/2	11 19/64
19	12 5/8	12 3/8	11 13/16	13 1/8	11 59/64
20	13 1/4	13	12 7/16	13 3/4	12 35/64
21	13 7/8	13 5/8	13 1/16	14 3/8	13 11/64
22	14 1/2	14 1/4	13 11/16	15	13 51/64
23	15 1/8	14 7/8	14 5/16	15 5/8	14 27/64
24	15 3/4	15 1/2	14 15/16	16 1/4	15 3/64
25	16 3/8	16 1/8	15 9/16	16 7/8	15 43/64
26	17 5/8	17 3/8	16 13/16	18 1/8	*

NUMBER OF POLES	A	B	C	D	E
27	18 1/4	18	17 7/16	18 3/4	*
28	18 7/8	18 5/8	18 1/16	19 3/8	
29	19 1/2	19 1/4	18 11/16	20	*
30	20 1/8	19 7/8	19 5/16	20 5/8	
31	20 3/4	20 1/2	19 15/16	21 1/4	*
32	21 3/8	21 1/8	20 9/16	21 7/8	
33	22	21 3/4	21 3/16	22 1/2	*
34	22 5/8	22 3/8	21 13/16	23 1/8	
35	23 1/4	23	22 7/16	23 3/4	*
36	23 7/8	23 5/8	23 1/16	24 3/8	
37	24 1/2	24 1/4	23 11/16	25	*
38	25 1/8	24 7/8	24 5/16	25 5/8	
39	25 3/4	25 1/2	24 15/16	26 1/4	*
40	26 3/8	26 1/8	25 9/16	26 7/8	
41	27	26 3/4	26 3/16	27 1/2	*
42	27 5/8	27 3/8	26 13/16	28 1/8	
43	28 1/4	28	27 7/16	28 3/4	*
44	28 7/8	28 5/8	28 1/16	29 3/8	
45	29 1/2	29 1/4	28 11/16	30	*
46	30 1/8	29 7/8	29 5/16	30 5/8	
47	30 3/4	30 1/2	29 15/16	31 1/4	*
48	31 3/8	31 1/8	30 9/16	31 7/8	
49	32	31 3/4	31 3/16	32 1/2	*
50	32 5/8	32 3/8	31 13/16	33 1/8	
51	33 7/8	33 5/8	33 1/16	33 3/4	*
52	34 1/2	34 1/4	33 11/16	34 3/8	

Note: To provide extra mounting support, at 26 poles one blank space is added; at 51 poles two blank spaces are added.
 * Panel cutout mounting not recommended

STATES Type MTS Front-Connected Switches

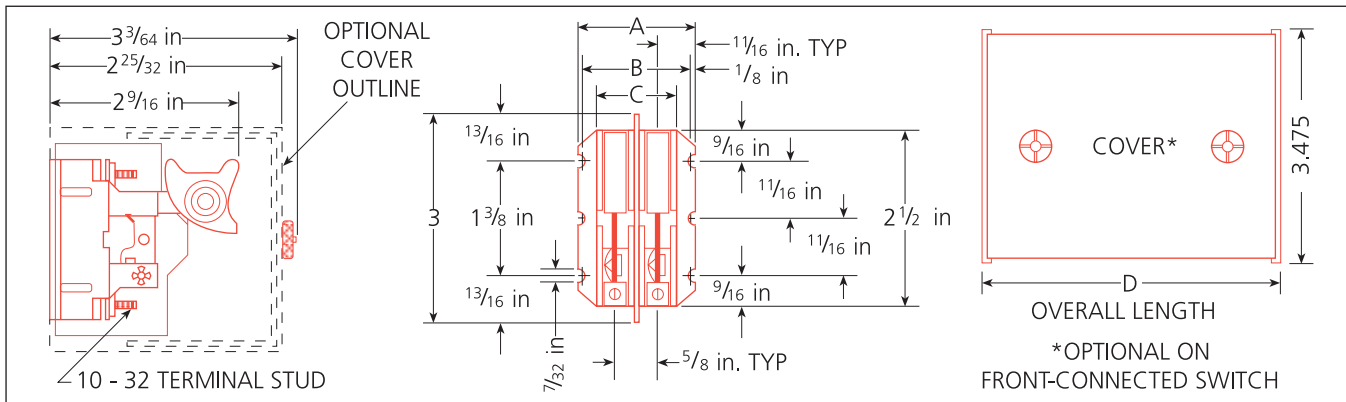

STATES Type MTS Back-Connected Switches

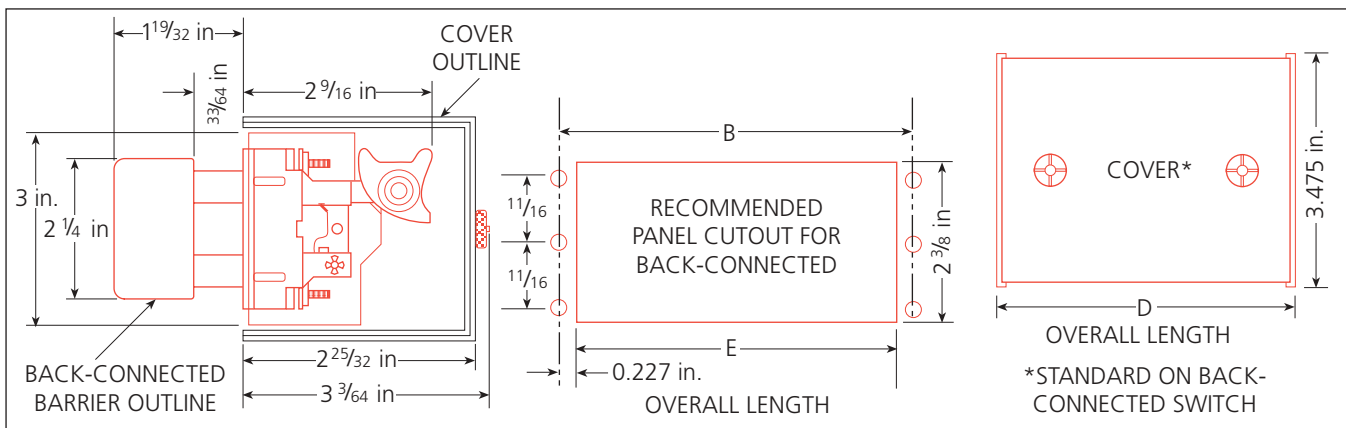

Color Key: k: Black b: Blue g: Green e: Orange r: Red w: White y: Yellow

STATES

4271 BRONZE WAY
DALLAS TX 75237-1019 USA
Ph: 1 800 325 4574
Toll Free: 1 214 331 7316
Fax: 1 214 331 7368
Email: states@megger.com
Web: www.statesproducts.com